

ITCB Twin HV (High Volume) 120/240V

Height: 35.0" Width: 20.5" Depth: 24.0"
(88.9cm) (52.1cm) (61.0cm)



- Sleek modernized design language, with rounded angles on the corners and trunk
- Brews into 1.5 gallon and 1.0 gallon BUNN Thermofresh servers for coffee, and TD4T, TDO and TDO-N tea dispensers
- Digital readout displays in English, Spanish, or French --- for easier programming and control
- Large 5.6 gallon (21.2L) tank provides back-to-back brewing capacity
- BUNN Infusion Series technology allows for multiple recipes from one footprint --- with three brew buttons and two batch sizes
- Tea brewing capability built-in with integrated dilution nozzle, software and Quick Brew tea brewing funnel
- Energy-saver mode reduces tank temperature during idle periods
- Exclusive Peak Extraction™ Sprayhead is multi-directional with a 17-hole design to ensure ultimate uniformity of extraction
- Electronic funnel lock prevents removal of each brew funnel until drip- through is complete
- USB programming capable
- Brews coffee or tea on both sides - Mix and Match to meet your needs
- Pre-infusion and pulse brew for maximum flavor extraction. Cold brew lockout & digital temperature control further ensure top-notch brewing.
- Hot water faucet (supplied for custom installation)

Servers Sold Separately

Agency:



Specifications

Product #: 52400.0100

Water Access: Plumbed

Finish: Stainless

Additional Features

Electrical & Capacity

Volts*	Amps	Watts	Cord Attached	Plug Type	8oz cups/hr 236ml cups/hr	Input H ₂ O Temp.	Phase	# Wires plus Ground	Hertz
120/240	25	6000	Yes/	-	672	60°F (15.5°C)	1	3	60

*When a BUNN is machine rated 120/208-240V, 120/208V or 120/240V, the higher voltage is the supply voltage needed to power the machine. The 120V is there to supply power to some components rated 120V in the machine, but it is not the supply voltage and would not power the machine if the machine is marked with the before mentioned ratings.

Plumbing Requirements

PSI	kPa	Fitting Supplied	Water Flow Required (GPM)
20-90	138-621	3/8" BSPP	1.25

CAD Drawings

2D	Revit	KLC
●		

WARNING: This product can expose you to chemicals including Bisphenol A (BPA), which is known to the State of California to cause birth defects or other reproductive harm. For more information go to www.P65Warnings.ca.gov



BUNN® reserves the right to change specifications and product design without notice. Such revisions do not entitle the buyer to corresponding changes, improvements, additions or replacements for previously purchased equipment. For most current specifications and other info visit bunn.com.

Last Updated:
08/27/2025

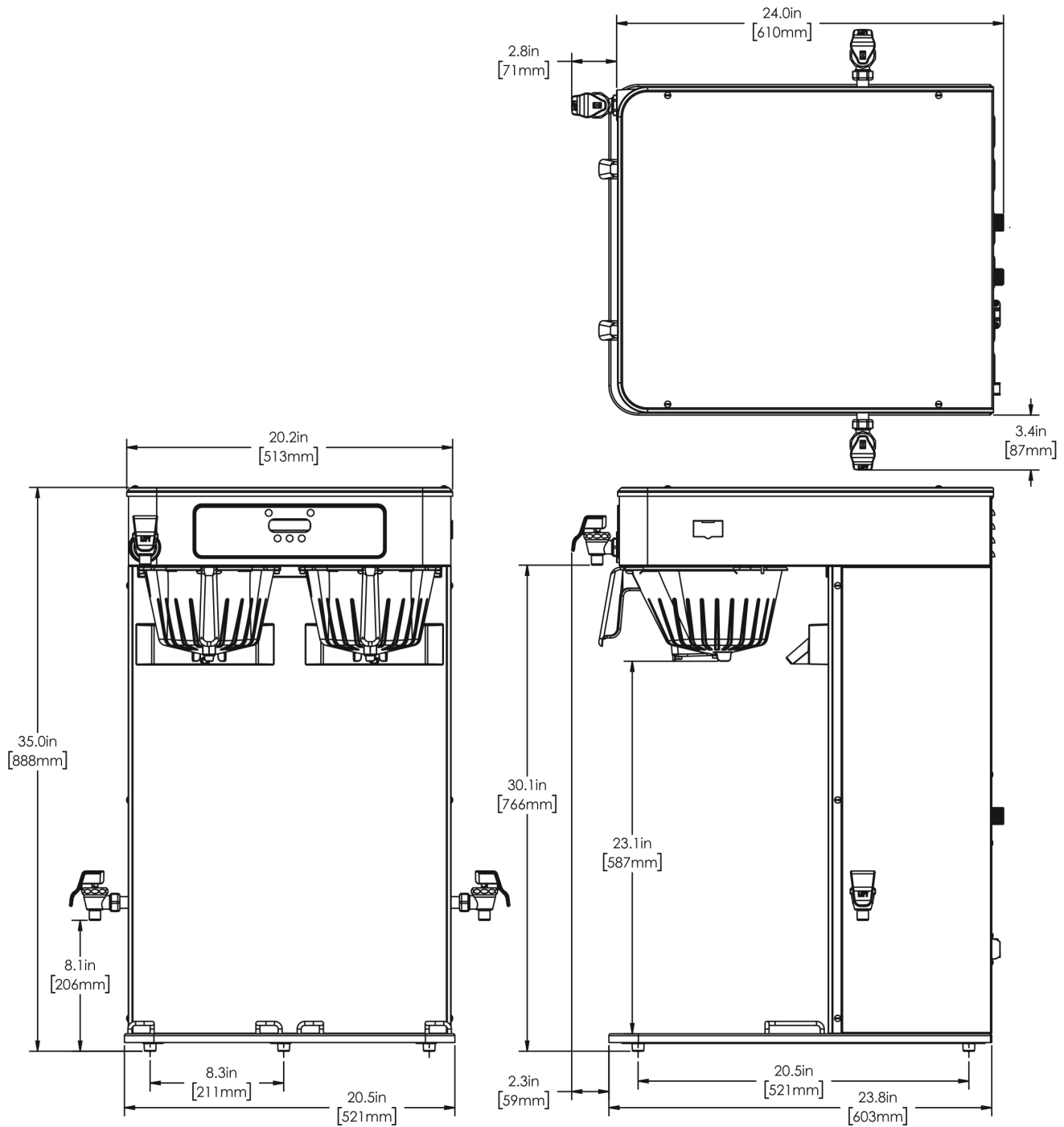















	Unit			Shipping				
	Height	Width	Depth	Height	Width	Depth	Weight	Volume
English	35.0 in.	20.5 in.	24.0 in.	38.3 in.	24.4 in.	28.6 in.	95.210 lbs	15.411 ft ³
Metric	88.9 cm	52.1 cm	61.0 cm	97.2 cm	61.9 cm	72.6 cm	43.187 kgs	0.436 m ³



BUNN® reserves the right to change specifications and product design without notice. Such revisions do not entitle the buyer to corresponding changes, improvements, additions or replacements for previously purchased equipment. For most current specifications and other info visit bunn.com.

Last Updated:
08/27/2025

Related Products & Accessories:ITCB Twin HV (High Volume) 120/240V(52400.0100)

 <p>FILTERS, GOURMET 500 500/1 50/CL</p> <p>Product #: 20138.1000</p>	 <p>WATER FILTER, EQHP-10</p> <p>Product #: 39000.0004³</p>	 <p>WATER FILTER, EQHP- TEA</p> <p>Product #: 39000.0007</p>	 <p>FUNNEL ASSY, SMART COFFEE BLK-CLEARED</p> <p>Product #: 53463.0021</p>	 <p>FUNNEL ASSY, TEA NATURAL QUICK BREW</p> <p>Product #: 53463.0023</p>
 <p>FUNNEL ASSY, TEA NATURAL QUICK BREW</p> <p>Product #: 53463.0036</p>	 <p>FUNNEL ASSY, SMART COFFEE BLK-CLEARED</p> <p>Product #: 53463.0038²</p>	 <p>FUNNEL ASSY, TEA NATURAL QUICK BREW</p> <p>Product #: 53463.0039²</p>	 <p>STAND ASSY KIT, TF SERVER</p> <p>Product #: 54473.1000</p>	 <p>SYSTEM, WQ-55(2)5</p> <p>Product #: 56000.0004¹</p>
 <p>SYSTEM, WQ-SFTN4000 (1.5)10 TEA</p> <p>Product #: 56000.0021¹</p>	 <p>SYSTEM, WEQ-10(1.5)5L</p> <p>Product #: 56000.0024¹</p>	 <p>SYSTEM, WEQ-10(1.5)5</p> <p>Product #: 56000.0027¹</p>	 <p>SYSTEM, WEQ- SFTN3500(1)10 TEA</p> <p>Product #: 56000.0030</p>	 <p>CARTRIDGE, WQ-55(2)5</p> <p>Product #: 56000.0104¹</p>

¹NSF Certified ²NSF Certified with spec sheet model listed ³NSF Certified under Solventum Purification ⁴NSF Certified under Mavea LLC ⁵NSF Certified under Zojirushi ⁶NSF Certified under Qins Inc ⁷NSF COMPONENT Certified



BUNN® reserves the right to change specifications and product design without notice. Such revisions do not entitle the buyer to corresponding changes, improvements, additions or replacements for previously purchased equipment. For most current specifications and other info visit bunn.com.

Last Updated:
08/27/2025

Related Products & Accessories:ITCB Twin HV (High Volume) 120/240V(52400.0100)



CARTRIDGE, WEQ-10
(1.5)5L

Product #: 56000.0121¹



CARTRIDGE, WEQ-10
(1.5)5

Product #: 56000.0122¹



CARTRIDGE, WEQ-
SFTN3500(1)10 TEA

Product #: 56000.0129¹



CARTRIDGE, WQ-
SFTN4000(1.5)10 TEA

Product #: 56000.0133¹



BUNN® reserves the right to change specifications and product design without notice. Such revisions do not entitle the buyer to corresponding changes, improvements, additions or replacements for previously purchased equipment. For most current specifications and other info visit bunn.com.

Last Updated:
08/27/2025

Serving & Holding Options: ITCB Twin HV (High Volume) 120/240V(52400.0100)



TD4, SIGHT GAUGE
SWT/UNSWT HDL

Product #: 03250.0003¹



TD4T, SIGHT GAUGE
NUDGER HDL

Product #: 03250.0004¹



TD4T, BREW THRU LID
NUDGER HDL

Product #: 03250.0005¹



TD4, BREW THRU LID
SWT/UNSWT HDL

Product #: 03250.0006¹



TD4T, BREW THRU LID
NO DECAL NUDGER
HDL

Product #: 03250.0018¹



AIRPOT, 2.5L SST LA
SINGLE PK

Product #: 32125.0000⁶

Mfr#:SVAP-2500F-N



TDS-3, 3 GAL

Product #: 33000.0000¹



TDS-3.5, 3.5 GAL

Product #: 33000.0023¹



TDO-4, RESERVOIR

Product #: 34100.0000¹



TDO-5, RESERVOIR

Product #: 34100.0001¹



TDO-4, RESERVOIR
BREW THRU

Product #: 34100.0002¹



TDO-5, RESERVOIR,
BREW THRU

Product #: 34100.0003¹



TDO-N-3.5, RSVR

Product #: 39600.0001¹



TDO-N-3.5, RSVR W/
LIFT HANDLE

Product #: 39600.0031¹



TDO-N-3.5, RSVR W/
PINCH TUBE

Product #: 39600.0047¹



BUNN® reserves the right to change specifications and product design without notice. Such revisions do not entitle the buyer to corresponding changes, improvements, additions or replacements for previously purchased equipment. For most current specifications and other info visit bunn.com.

Last Updated:
08/27/2025

Serving & Holding Options: ITCB Twin HV (High Volume) 120/240V(52400.0100)



TF SERVER, 1G DSG
GEN3

Product #: 42700.0200¹



TF SERVER, 1.5G DSG
GEN3

Product #: 42750.0200¹



TD3T-N, RSVR BREW
THRU LID BUNN

Product #: 43900.0001¹



TD3T-N, RSVR SOLID
LID BUNN

Product #: 43900.0002¹



TF SERVER, 1G MECH
GEN3

Product #: 44000.0200¹



TF SERVER, 1.5G MECH
GEN3

Product #: 44050.0200¹



BUNN® reserves the right to change specifications and product design without notice. Such revisions do not entitle the buyer to corresponding changes, improvements, additions or replacements for previously purchased equipment. For most current specifications and other info visit bunn.com.

Last Updated:
08/27/2025